

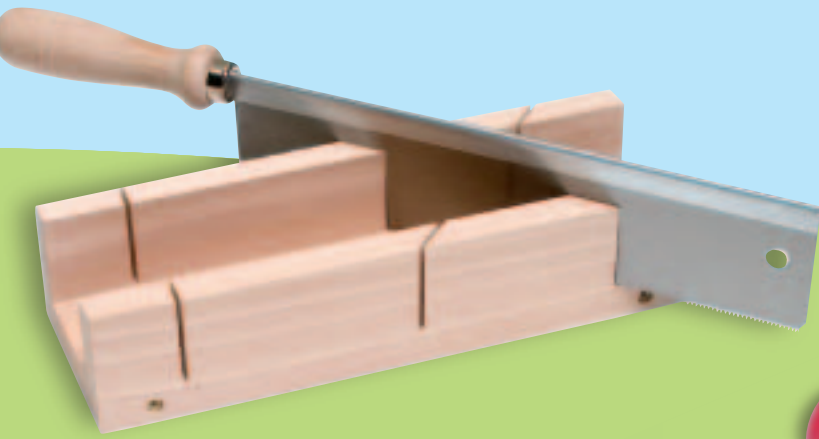

BASTLER- WERKZEUGE

DIY TOOLS



Hämmer hammers

Art. 26-90
Klauenhammer, 90 g
Stahl

Art. 26-90
claw hammer, 90 g
steel



Art 26-S250
Klauenhammer, 250 g
Stahl geschmiedet

Art 26-S250
claw hammer, 250 g
forged steel



Art. 26-70
Schlosserhammer, 70 g
Stahl geschmiedet

Art. 26-70
machinist's hammer, 70 g
forged steel



Art. 26-100
Schlosserhammer, 100 g
Stahl geschmiedet

Art. 26-100
machinist's hammer, 100 g
forged steel

Art. 26-200
Schlosserhammer, 200 g
Stahl geschmiedet

Art. 26-200
machinist's hammer, 200 g
forged steel



Art. 26-300
Schlosserhammer, 300 g
Stahl geschmiedet

Art. 26-300
machinist's hammer, 300 g
forged steel



Art. 26-500
Schlosserhammer, 500 g
Stahl geschmiedet

Art. 26-500
machinist's hammer, 500 g
forged steel



Art. M2252000
Ausbeulhammer, Ø 30 mm
Kopflänge 95 mm

Art. M2252000
soft-faced hammer, Ø 30 mm
head length 95 mm



Art. M2255500
Holzhammer, Ø 45 mm
Kopflänge 120 mm

Art. M2255500
wooden hammer, Ø 45 mm
head length 120 mm

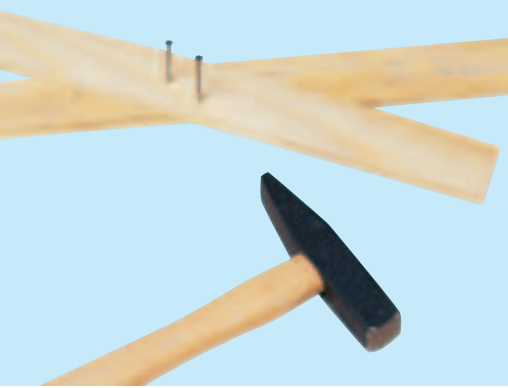
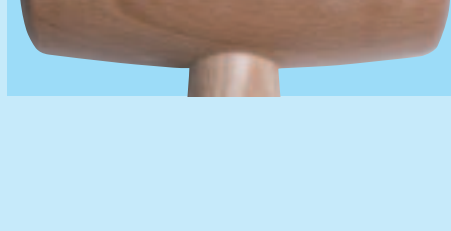

Bohren drilling



- 1) Art. NA2S - Nagelbohrer, 2 mm, auf Karte
- 1) Art. NA2S - gimlet, 2 mm, on card
- 2) Art. NA3S - Nagelbohrer, 3 mm, auf Karte
- 2) Art. NA3S - gimlet, 3 mm, on card
- 3) Art. NA4S - Nagelbohrer, 4 mm, auf Karte
- 3) Art. NA4S - gimlet, 4 mm, on card
- 4) Art. NA5S - Nagelbohrer, 5 mm, auf Karte
- 4) Art. NA5S - gimlet, 5 mm, on card
- Art. NA2-3-4-5 - Nagelbohrer-Set
4 Stück auf Karte
- Art. NA2-3-4-5 - gimlet-set
4 pcs. on card
- 5) Art. NA2-3-4-5Halter - Halter für Kastanien
mit 5 Löchern
- 5) Art. NA2-3-4-5Halter - holder for chestnuts
with 5 holes



Art. HSS250 - PROFILINE Bohrer
Alle Kleinbohrer von 0,3 bis 2,5 mm in einer
Kassette inkl. Aluminium-Handhalter mit Schnell-
spannfutter (Spannbereich von 0,3 - 3,2 mm) und
magnetischer Bohreraufbewahrung im Griff.
40 HSS Spiralbohrer: rechts, zylindrisch, DIN 338,
Typ N. Die Kassette ist bestückt mit jeweils
2 Bohrern der Größen: Ø 0,3 / 0,4 / 0,5 / 0,6 / 0,7 /
0,8 / 0,9 / 1,0 / 1,1 / 1,2 / 1,3 / 1,4 / 1,5 / 1,6 / 1,8 /
2,0 / 2,2 / 2,3 / 2,4 / 2,5 mm



Art. HSS03/10 bis HSS40/10
HSS Spiralbohrer, alle Größen ab
0,3 bis 4,0 mm, 10 Stück in Tüte
verpackt (0,1 mm steigend)
Art. HSS03/10 to HSS40/10
HSS twist drills, in all sizes from
0.3 to 4.0 mm, 10 pcs. in bag
(0.1 mm upward)

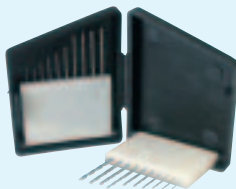

Art. HSS200 - HSS Spiralbohrersatz,
20-teilig, 0,3 - 1,2 mm (siehe HSS250)
Art. HSS200 - HSS twist drill set,
20 pcs., 0.3 - 1.2 mm (as HSS250)

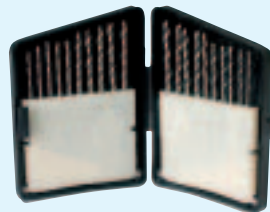

Art. HSS225 - HSS Spiralbohrersatz,
20-teilig, 1,3 - 2,4 mm (siehe HSS250)
Art. HSS225 - HSS twist drill set,
20 pcs., 1.3 - 2.4 mm (as HSS250)

Art. HSS40/10 bis HSS100/10
HSS Spiralbohrer, alle Größen ab
4,0 bis 10,0 mm, 10 Stück in Tüte
verpackt (0,5 mm steigend)
Art. HSS40/10 to HSS100/10
HSS twist drills, in all sizes from
0.4 to 10.0 mm, 10 pcs. in bag
(0.5 mm upward)



Art. 1539 - Werkzeughalter mit gerändeltem und vernickeltem
Messingheft, drehbarer Handauflage mit Schraubkopf und
2 gehärteten, doppelseitigen Spannzangen für folgende Spannbe-
reiche: 0,1 - 1,1 / 1,0 - 2,0 / 2,0 - 2,5 / 2,5 - 3,2 mm

Art. 1539 - pin vice - with knurled brass handle, nickel plated, with
turning hand rest and 2 hardened collet chucks at both ends.
Clamping range: 0.1 - 1.1 / 1.0 - 2.0 / 2.0 - 2.5 / 2.5 - 3.2 mm



Art. 0281 - Akku-Bohrmaschine für Bohrer 0,3 bis 3,2 mm
inkl. Netzteil und 4 Spannzangen Spannbereich 0,3 bis 3,2 mm
Art. 0281 - cordless drilling machine with charger and 4 collets
range 0.3 to 3.2 mm



Bohren und Schrauben drilling and screwing



Art. 2010 - Kinder Akkuschauber mit Vor- und Rücklauf zum Ein- und Ausschrauben!
H 13 x T 14 cm, Drehzahl: max. 180 U/Min, Drehmoment: max. 3 Nm, Lithium-Ionen-Akku: 3,6 Volt, Ladegerät: 230 V Netzspannung, 5 Std. Ladezeit, mit Tasche und 4 Einsätzen
Art. 2010 - cordless screwdriver for children with forward and reverse function for screwing/unscrewing, screwdriver: h 13 x d 14 cm, revolutions max. 180 rpm, torque max. 3Nm, lithium ion rechargeable battery 3.6V., charger: 230V mains voltage, 5 hrs charging time, with bag and 4 fittings



Präzisions-Schnellspannfutter mit eingeschliffenen Backen
precision chuck with lapped jaws

Art. 1532 - Ø 0,4 - 3,5 mm mit Gewinde M8 (z.B. für Proxxon)
Art. 1532 - dia. 0.4 - 3.5 mm with threads M8 (for Proxxon)

Art. 1534 - Ø bis 6 mm mit Gewinde M8 (z.B. für Proxxon)
Art. 1534 - up to dia. 6 mm with threads M8 (for Proxxon)

Art. 1531 - Ø 0,4 - 3,5 mm mit Gewinde 280-40NS (z.B. für Dremel)
Art. 1531 - dia. 0.4 - 3.5 mm with threads 280-40NS (for Dremel)

Art. 1536 - Ø bis 6 mm mit Gewinde 280-40NS (z.B. für Dremel)
Art. 1536 - up to dia. 6 mm with threads 280-40NS (for Dremel)



1) Art. 1540 - Magnetischer Hand-Bithalter
Halterlänge ohne Einsätze 150 mm,
für alle 1/4" Bits und den 6-Kant-Stift
Art. 1544

1) Art. 1540 - magnetic hand holder
holder length without inserts 150 mm,
for all 1/4" bit-inserts and our insert
art. 1544



2) Art. 1544 - Der 6-Kant-Stift mit Schaft (6,35 mm = 1/4") ist passend für alle Akku-Schauber mit 1/4" Bithalter. Sie können ihn mit unseren beiden Bohrfuttern Art. 1532 und 1534 ausrüsten.

2) Art. 1544 - This insert is to use in all battery screwdrivers with 1/4" holder. You can use our chucks art. 1532 and 1534 with this insert.



Art. 22-1 - Dreiback-Bohrfutter bis 8 mm
Art. 22-1 - precision chuck up to 8 mm



Art. 22/8 - Handbohrmaschine mit Doppelgetrieberahmen und zusätzlichem Halteknopf, Dreiback-Bohrfutter bis 8 mm
Art. 22/8 - professional hand drill, precision chuck up to 8 mm



Art. 22/10BR - Brustbohrmaschine, Dreiback-Bohrfutter bis 13 mm
Art. 22/10BR - breast drill with precision chuck up to 13 mm

Art. 22 - Handbohrmaschine „Standard“, Dreiback-Bohrfutter bis 6 mm
Art. 22 - hand drill, precision chuck up to 6 mm

Bastlerzangen

DIY pliers

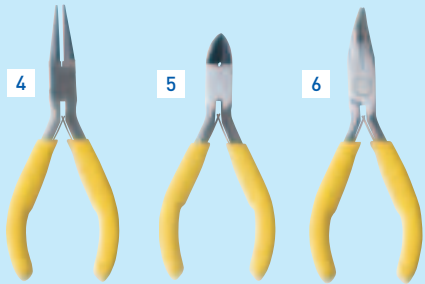
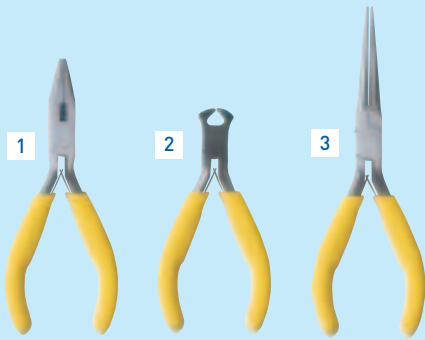

- 1) Art. 3600/1 - Spitzzange gerade mit Feder, 125 mm
- 1) Art. 3600/1 - snipe nose pliers straight with spring, 125 mm
- 2) Art. 3600/2 - Vornscheider mit Feder, 110 mm
- 2) Art. 3600/2 - endcutter with spring, 110 mm
- 3) Art. 3600/3 - Storchenschnabelzange mit Feder, 150 mm
- 3) Art. 3600/3 - long nose pliers with spring, 150 mm
- 4) Art. 3600/4 - Rundzange mit Feder, 125 mm
- 4) Art. 3600/4 - round nose pliers with spring, 125 mm
- 5) Art. 3600/5 - Seitenschneider mit Feder, 110 mm
- 5) Art. 3600/5 - side cutter with spring, 110 mm
- 6) Art. 3600/6 - Spitzzange gebogen mit Feder, 120 mm
- 6) Art. 3600/6 - snipe bent nose pliers with spring, 120 mm
- 7) Art. 247 - Zangensatz, mit Feder, 6-tlg. (Art. 3600/1 - 3600/6 in Tasche)
- 7) Art. 247 - pliers set, 6 pcs. (Art. 3600/1 - 3600/6 in case)

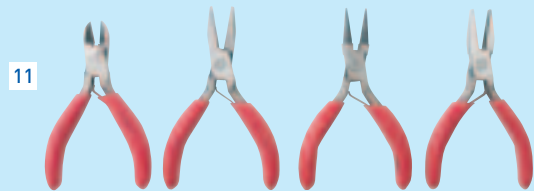

- 8) Art. 248S - Präzisions-Spitzzange mit Feder, Soft Grip, 130 mm
- 8) Art. 248S - professional snipe nose pliers with spring, soft grip, 130 mm
- 9) Art. 253S - Präzisions-Seitenschneider mit Feder, Soft Grip, 120 mm
- 9) Art. 253S - professional side cutter with spring, soft grip, 120 mm
- 10) Art. 254S - Präzisions-Spitzzange gebogen mit Feder, Soft Grip, 130 mm
- 10) Art. 254S - professional snipe bent nose pliers with spring, soft grip, 130 mm
- Art. 257 - Zangensatz 3-tlg. auf Karte (Art. 248S, 253S, 254S)
- Art. 257 - pliers set 3 pcs. on card (art. 248S, 253S, 254S)

- 11) Art. 246 - Mikro Zangensatz auf Karte, Flachzange, Rundzange, Spitzzange, Seitenschneider, mit Feder, 75 - 80 mm
- 11) Art. 246 - micro piers set on card, flat nose pliers, round nose pliers, snipe nose pliers, side cutter, with spring, 75 - 80 mm

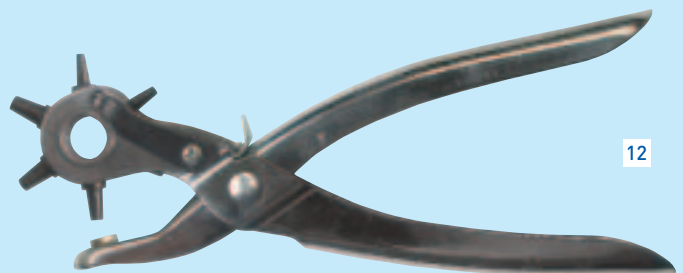

- 12) Art. 265 - Revolverlochzange, 200 mm
- 12) Art. 265 - revolving punch pliers, 200 mm

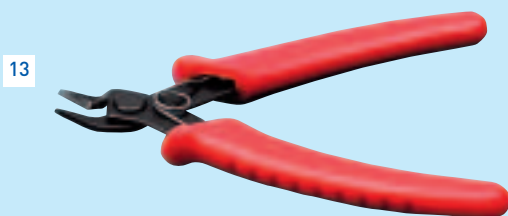

- 13) Art. NC20 - Seitenschneider, mit Feder, Kupferdraht bis 1,2 mm
- 13) Art. NC20 - side cutter, with spring, copper wire up to 1.2 mm



- 14) Art. 25 - Kantenzange, Stahl, 130 mm, 5"
- 14) Art. 25 - carpenter's pincers, steel, 130 mm, 5"



- 15) Art. 25/160 - Kantenzange, Stahl, 155 mm, 6"
- 15) Art. 25/160 - carpenter's pincers, steel, 155 mm, 6"

Handsägen und Gehrungsschneidladen

saws and mitre boxes

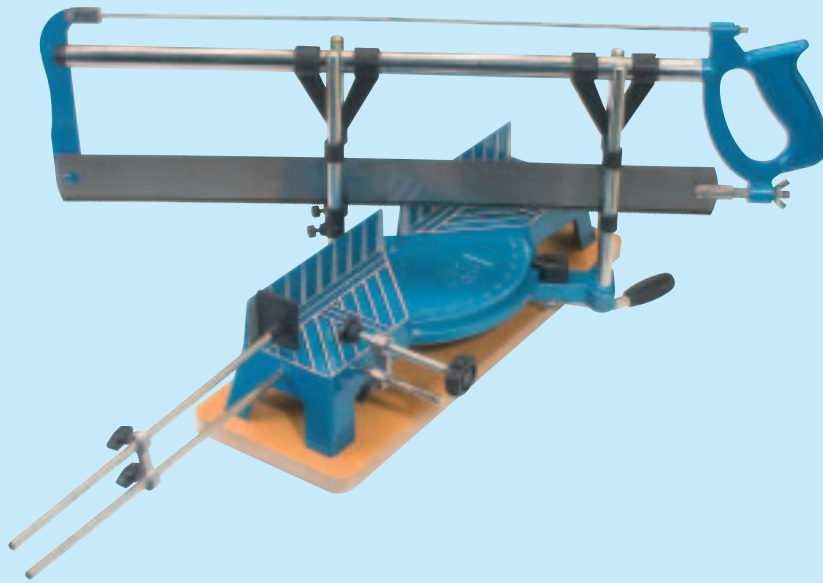

Art. 80 - Gehrungssäge, für Holz, 550 mm
Art. 80 - mitre box saw, for wood, 550 mm

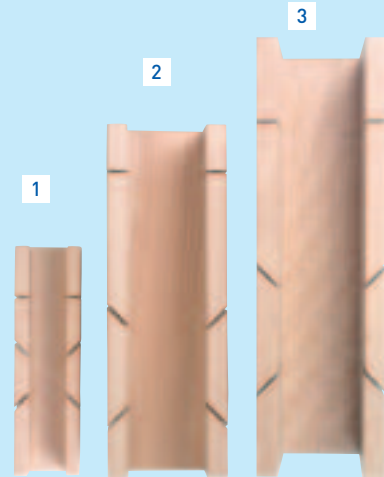
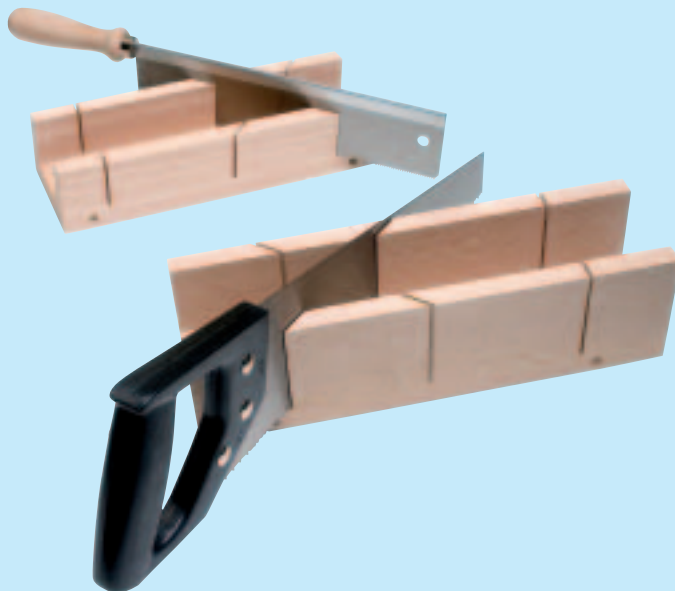

- 1) Art. 97/165 - Gehrungsschneidlade
Buche massiv, 165 mm
- 1) Art. 97/165 - mitre box
beech wood, 165 mm
- 2) Art. 97/250 - Gehrungsschneidlade
Buche massiv, 250 mm
- 2) Art. 97/250 - mitre box
beech wood, 250 mm
- 3) Art. 97/300 - Gehrungsschneidlade
Buche massiv, 300 mm
- 3) Art. 97/300 - mitre box
beech wood, 300 mm



Art. 29/300 - Handsäge mit
Kunststoffheft, für Holz, 300 mm
Art. 29/300 - handsaw with plastic
handle, for wood, 300 mm



Art. 29 - Handsäge mit Kunststoffheft
für Holz, 200 mm
Art. 29 - handsaw with plastic handle
for wood, 200 mm



4

- 4) Art. 77/60 - Feinsäge mit Buchenholzheft
für Holz, 60 mm
- 4) Art. 77/60 - tenon saw with wooden handle
for wood, 60 mm



5

- 5) Art. 77/60KR - Feinsäge mit Buchenholzheft
gekröpft, für Holz, 60 mm
- 5) Art. 77/60KR - tenon saw with wooden handle
cranked, for wood, 60 mm



Holzständer für Sägebogen und Holztischchen

wooden sawframe holders and cutting tables



- 1) Art. ST10-790PEBARO - Holzständer für 10 Laubsägebogen Art. 750K und 790
- 1) Art. ST10-790PEBARO - wooden holder for 10 fretsawframes art. 750K and 790
- 2) Art. ST10 - Holzständer für 10 Laubsägebogen Art. 701, 701W, 750 und 750N
- 2) Art. ST10 - wooden holder for 10 fretsawframes art. 701, 701W, 750 and 750N
- 3) Art. ST11 - Holzständer für 10 Sägebogen Art. 704
- 3) Art. ST11 - wooden holder for 10 sawframes art. 704
- 3) Art. ST12 - Holzständer für 10 Feinsägen Art. 77/60
- 3) Art. ST12 - wooden holder for 10 precision saws art. 77/60

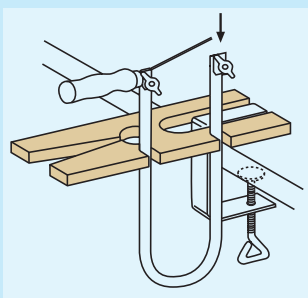
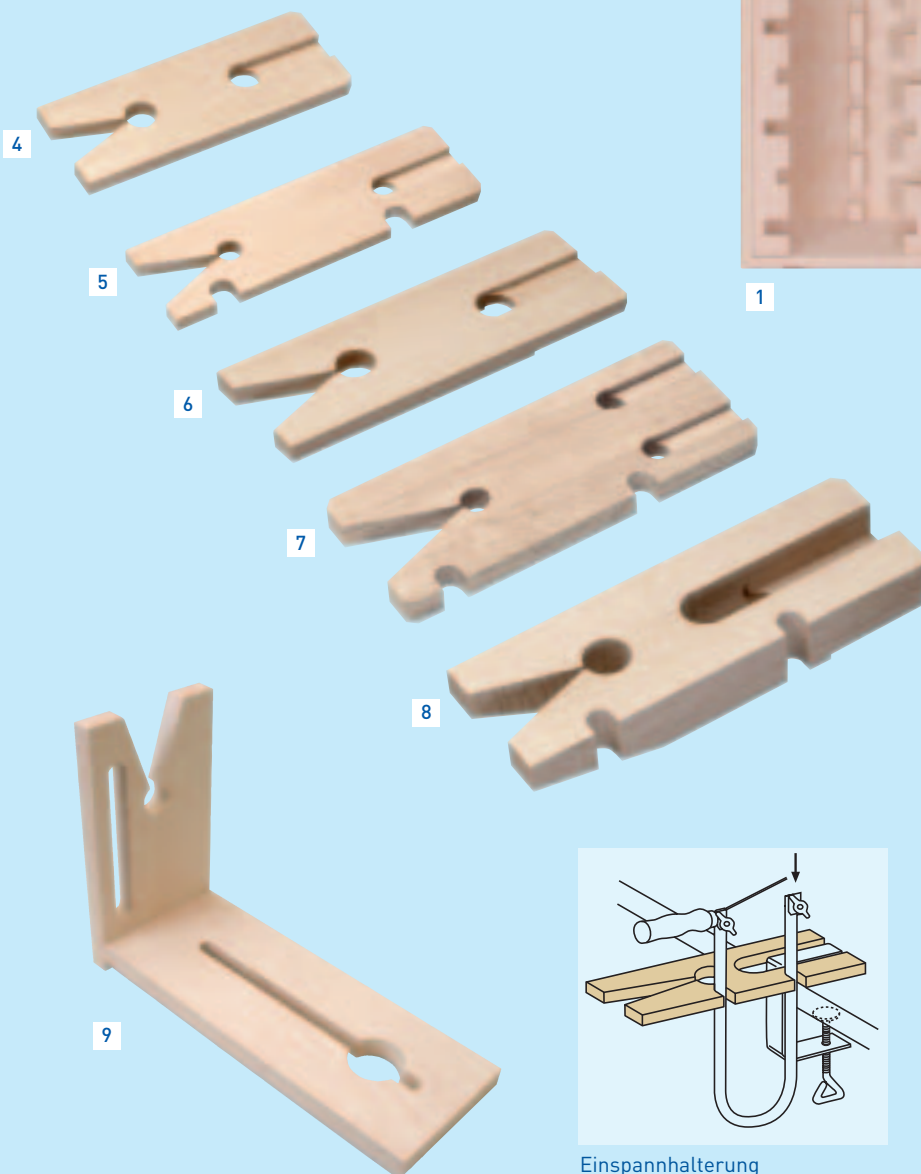

Einspannhalterung
clamping grooves

- 4) Art. 23 - Laubsägetischchen Standard 170 x 67 x 10 mm
- 4) Art. 23 - standard fretwork cutting table 170 x 67 x 10 mm
- 5) Art. 23N - Laubsägetischchen mit Einspannhalterung, 210 x 64 x 10 mm
- 5) Art. 23N - fretwork cutting table with clamping grooves, 210 x 64 x 10 mm
- 6) Art. 23/10 - Laubsägetischchen, 220 x 80 x 16 mm
- 6) Art. 23/10 fretwork cutting table, 220 x 80 x 16 mm
- 7) Art. 323 - Laubsägetischchen mit Einspannhalterung, 220 x 90 x 14 mm
- 7) Art. 323 - fretwork cutting table with clamping grooves, 220 x 90 x 14 mm
- 8) Art. 523 - Laubsägetischchen „Schule“ mit Einspannhalterung, 250 x 85 x 35 mm
- 8) Art. 523 - fretwork cutting table "school" with clamping grooves, 250 x 85 x 35 mm
- 9) Art. 525 - Laubsägetischchen „Winkel“ mit Einspannhalterung, höhenverstellbar, 215 x 120 x 16 mm
- 9) Art. 525 - fretwork cutting table "L-shape" with clamping grooves, adjustable in height, 215 x 120 x 16 mm

Feilen und Raspeln

files and rasps

Raspeln für Speckstein

rasps for soapstone



- 1) Art. 67 - Faustraspel, 70 x 100 mm
- 1) Art. 67 - ring rasp, 70 x 100 mm
- 2) Art. RA5 - Raspel-Set, 5-tlg., 200 mm
- 2) Art. RA5 - rasp set, 5 pcs., 200 mm
- 3) Art. RA8 - Raspel-Set, 8-tlg., doppelseitig, 200 mm
- 3) Art. RA8 - rasp set, 8 pcs., double-sided, 200 mm

Feilen für harte Materialien wie Stahl, Glas, Keramik usw.

files for hard materials as steel, glass, ceramic etc.

- 4) Art. DIA5 - Diamant-Nadelfeilensatz isolierter Schaft, 5 Nadelfeilen mit Diamantbeschichtung flach, rund, halbrund, dreikant, vierkant, 100 mm
- 4) Art. DIA5 - diamond files, insulating handle, 5 small files diamond coated flat, round, half-round, triangular, square, 100 mm
- 5) Art. DIA10 - Diamant-Nadelfeilensatz, isolierter Schaft, 10 Nadelfeilen mit Diamantbeschichtung flach, rund, halbrund, dreikant, vierkant usw., 140 mm
- 5) Art. DIA10 - diamond files, insulating handle, 10 files diamond coated flat, round, half-round, triangular, square, etc., 140 mm

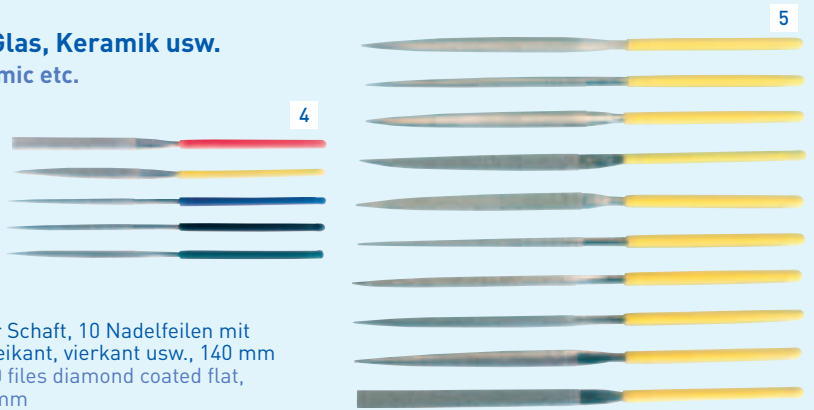

Feilen für weiche Materialien wie Holz, Kunststoff usw.

files for soft materials as wood, plastic etc.

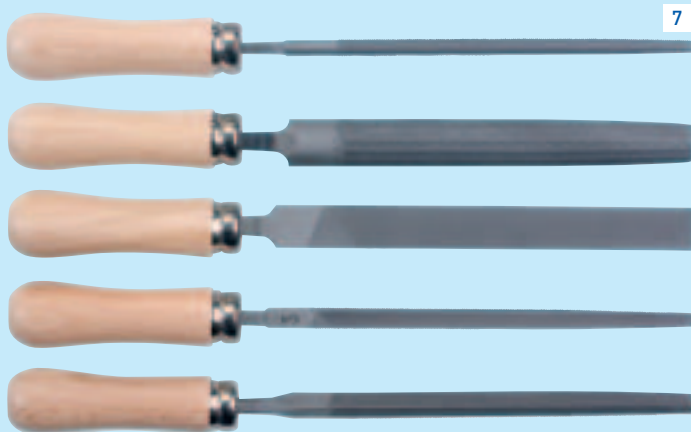
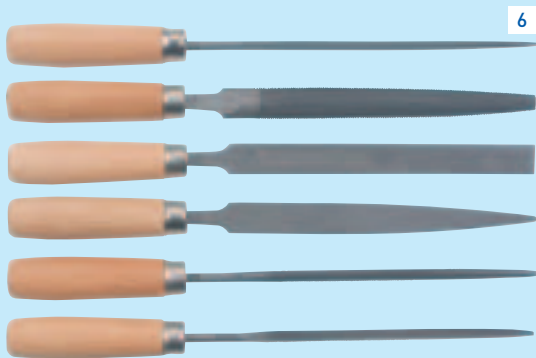

- 6) Art. 59 - Schlüsselfeilen-Set, 6-tlg. halbrund, dreikant, vierkant, flach, flachstumpf und rund, Heft Ø 14 mm, 170 mm
- 6) Art. 59 - needle files, 6 pcs. half-round, triangular, squared, flat tapered, warding (flat) and round, handle dia. 14 mm, 170 mm
- 7) Art. 60 - Bastlerfeilen-Set, 5-tlg. wie Art. 59, jedoch Heft Ø 24 mm, 240 mm
- 7) Art. 60 - DIY files, 5 pcs. as art. 59, handle dia. 24 mm, 240 mm
- 8) Art. M58 - Nadelfeilen-Set, 12-tlg. flach, flachspitz, halbrund, rund, dreikant, vierkant usw., Heft Ø 13 mm, 150 mm
- 8) Art. M58 - needle files, 12 pcs. flat-tapered, warding (flat), half-round, round, triangular, square etc., handle dia. 13 mm, 150 mm

Feilen mit Holzheft, lose files with wooden handle, loose

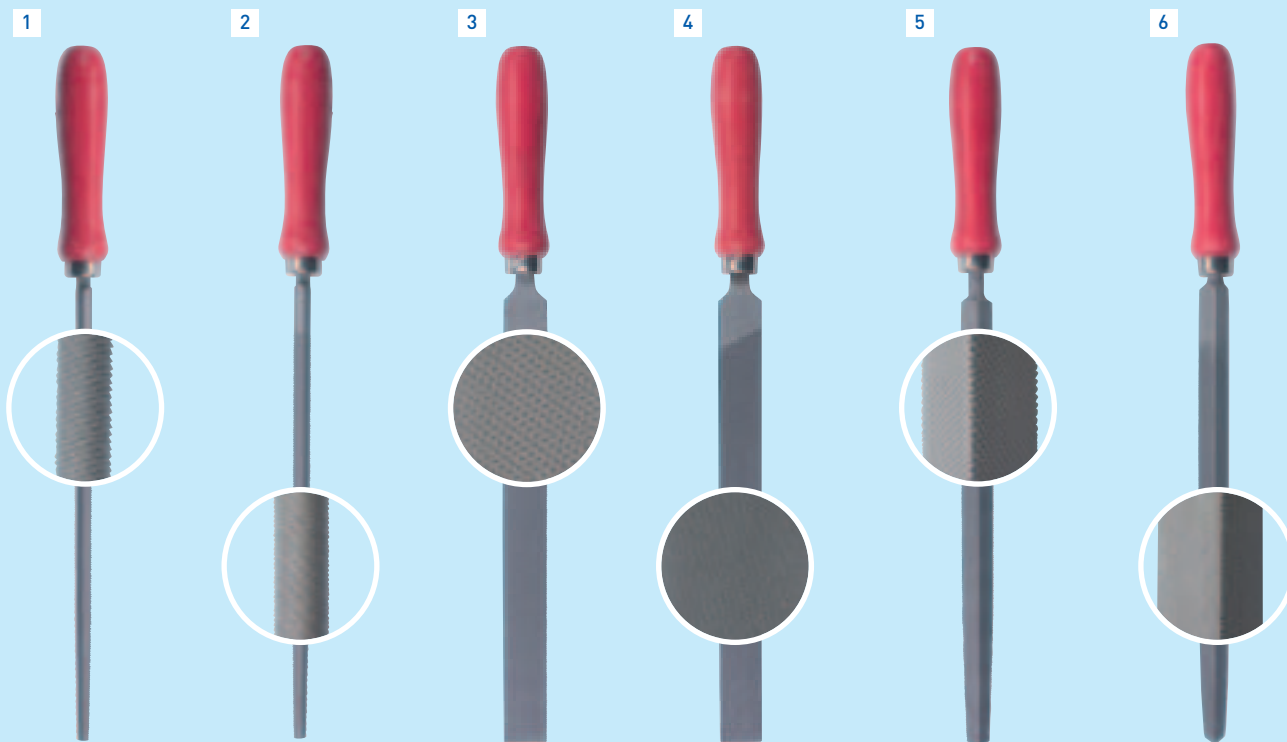

- 1) Art. 61 - Rundfeile, 200 mm, Hieb 1
1) Art. 61 - round file, 200 mm, cut 1
2) Art. 61-3 - Rundfeile, 200 mm, Hieb 3
2) Art. 61-3 - round file, 200 mm, cut 3
3) Art. 62 - Flachfeile, 200 mm, Hieb 1
3) Art. 62 - flat file, 200 mm, cut 1

- 4) Art. 62-3 - Flachfeile, 200 mm, Hieb 3
4) Art. 62-3 - flat file, 200 mm, cut 3
5) Art. 63 - Dreikantfeile, 200 mm, Hieb 1
5) Art. 63 - triangular file, 200 mm, cut 1
6) Art. 63-3 - Dreikantfeile, 200 mm, Hieb 3
6) Art. 63-3 - triangular file, 200 mm, cut 3

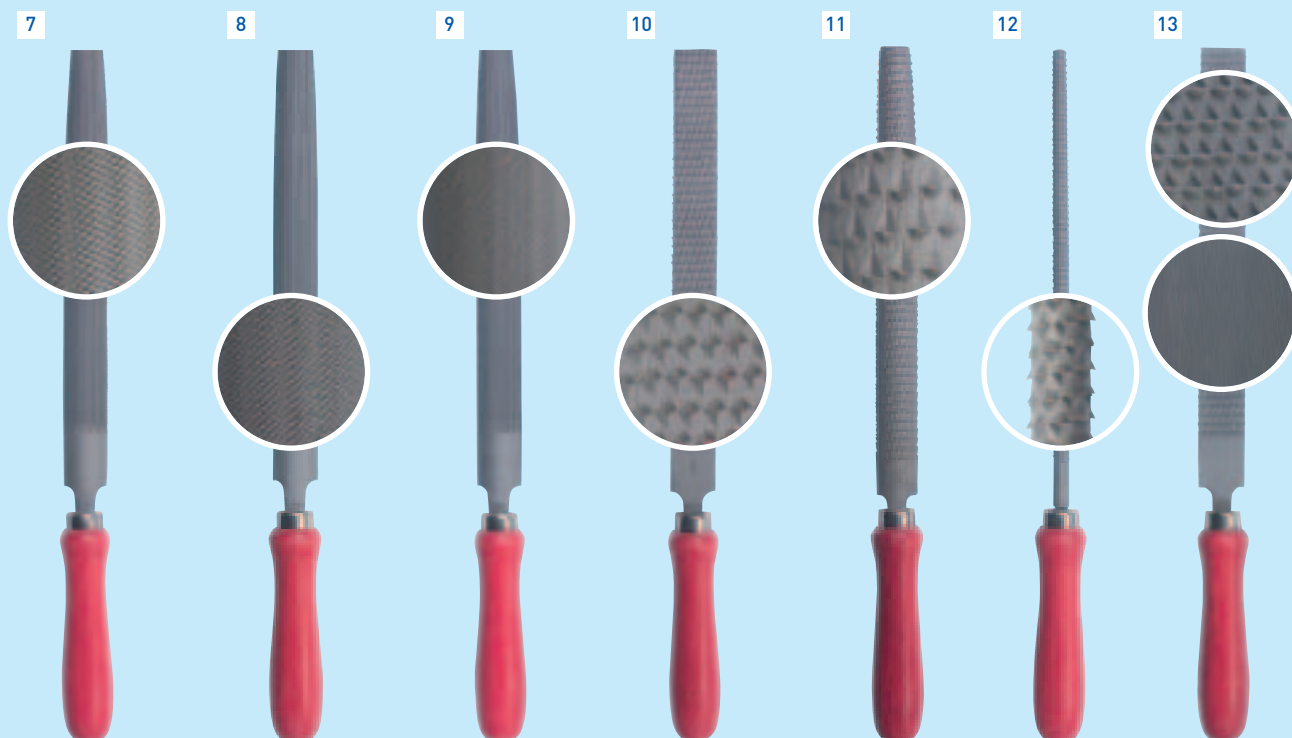

- 7) Art. 64 - Halbrundfeile, 200 mm, Hieb 1
7) Art. 64 - half round file, 200 mm, cut 1
8) Art. 64-2 - Halbrundfeile, 200 mm, Hieb 2
8) Art. 64-2 - half round file, 200 mm, cut 2
9) Art. 64-3 - Halbrundfeile, 200 mm, Hieb 3
9) Art. 64-3 - half round file, 200 mm, cut 3
10) Art. 65 - Flach Rasper, 200 mm, Hieb 1
10) Art. 65 - flat rasp, 200 mm, cut 1

- 11) Art. 66 - Halbrund Rasper, 200 mm, Hieb 1
11) Art. 66 - half round rasp, 200 mm, cut 1
12) Art. 68 - Rund Rasper, 200 mm, Hieb 1
12) Art. 68 - round rasp, 200 mm, cut 1
13) Art. 70 - Feilraspel flach, 200 mm, Hieb 1 und 3
13) Art. 70 - flat file and rasp, 200 mm, cut 1 and 3

Spannzwingen clamps

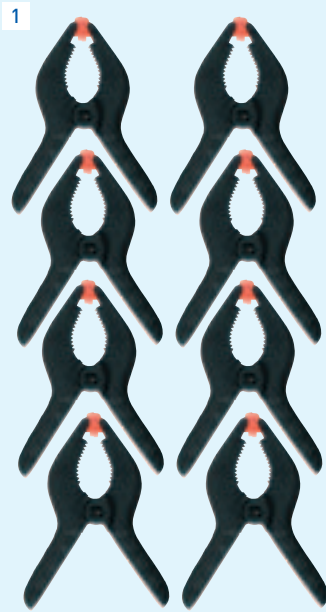

1

- 1) Art. 19-1S - 8 Mikro-Zwingen, 20 x 20 mm Spannweite
- 1) Art. 19-1S - 8 pcs. spring clamp set, 20 x 20 mm spread
- 2) Art. 19-2S - 4 Mini-Zwingen, 30 x 30 mm Spannweite
- 2) Art. 19-2S - 4 pcs. spring clamp set, 30 x 30 mm spread
- 3) Art. 19-3S - 2 Mini-Zwingen, 40 x 40 mm Spannweite
- 3) Art. 19-3S - 2 pcs. spring clamp set, 40 x 40 mm spread

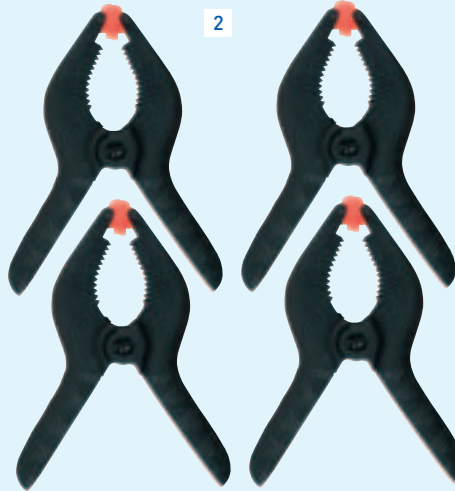

2



3

I Die beweglichen Greifbacken passen sich automatisch dem Werkstück an. Ergonomische Griffe, leichtes Gewicht, bruchfest.
Jaw nose pivots for secure. Even gripping, ergonomic handles, light weight, resin construction.



Art. 19-4S - Kunststoff-Zwinge,
60 x 60 mm Spannweite
Art. 19-4S - spring clamp,
60 x 60 mm spread

Art. 30-3S - 2 Ratschzwingen,
max. Spannweite 35 mm,
mit verstellbaren Schonbacken,
35 x 45 mm
Art. 30-3S - 2 ratcheting clamps,
jaw capacity 35 mm, with
adjustable grab cheeks,
35 x 45 mm

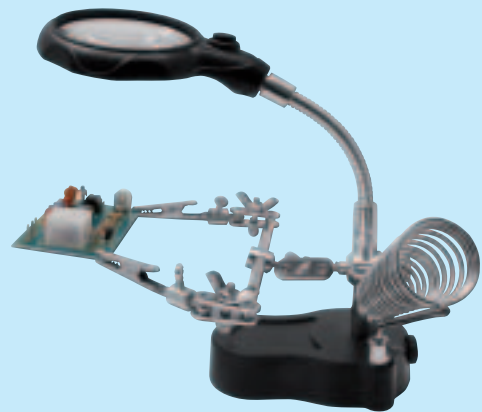
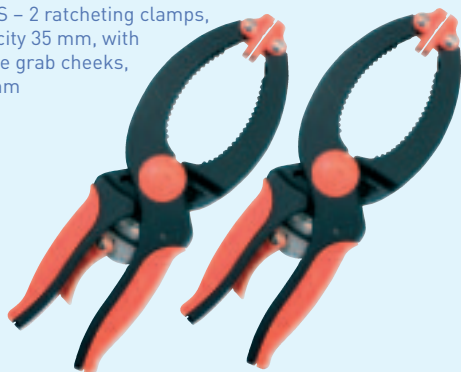

Art. HH 3 - Helping Hand mit LED-Licht und Lupe
Ein praktischer Helfer in Elektronik und Modellbau mit Lupe, LED-Beleuchtung für Arbeiten in dunkler Umgebung und einer Lötkolbenablage. Hauptlinse Ø 65 mm mit 3,5-facher Vergrößerung, Zusatzlinse mit 12-facher Vergrößerung. Krokodklemmen in alle Richtungen verstellbar. Lieferung inkl. 3 Batterien (AAA).
Art. HH 3 - helping hand with LED-light + magnifier
A useful aid for soldering work and modell makers with magnifier, LED light for work in dark environment and a soldering stand. Main lens dia. 65 mm with 3.5x magnifier, additional lens dia. 17 mm with 12x magnifier. With adjustable crocodile holding clamps. 3 pcs. of batteries (AAA) included.

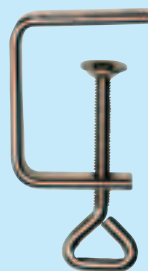

Art. 24/04 Laubsägezwingen vernickelt, 40 mm Spannweite, Flachstahl 13 x 4 mm
Art. 24/04 fretsaw clamps nickel-plated, span length 40 mm, flat steel 13 x 4 mm
Art. 24/05 Laubsägezwingen vernickelt, 50 mm Spannweite, Flachstahl 13 x 5 mm
Art. 24/05 fretsaw clamps nickel-plated, span length 50 mm, flat steel 13 x 5 mm
Art. 24/06 Laubsägezwingen vernickelt, 60 mm Spannweite, Flachstahl 13 x 5 mm
Art. 24/06 fretsaw clamps nickel-plated, span length 60 mm, flat steel 13 x 5 mm
Art. 24/07 Laubsägezwingen vernickelt, 70 mm Spannweite, Flachstahl 13 x 6 mm
Art. 24/07 fretsaw clamps nickel-plated, span length 70 mm, flat steel 13 x 6 mm
Art. 24/10 Laubsägezwingen vernickelt, 100 mm Spannweite, Flachstahl 13 x 6 mm
Art. 24/10 fretsaw clamps nickel-plated, span length 100 mm, flat steel 13 x 6 mm

Spannzwingen clamps



1) Art. 20S - Schnellspannzwinde, 100 mm Spannlänge, 30 mm Spanntiefe mit Schonbacken. Backen zum Spreizen umsteckbar.

1) Art. 20S - quick bar clamp and spreader, 100 mm span length, 30 mm depth. Nylon fibre filled jaws. Using for spreading too.

2) Art. 20S/300 - Schnellspannzwinde, 200 mm Spannlänge, 30 mm Spanntiefe mit Schonbacken. Backen zum Spreizen umsteckbar.

2) Art. 20S/300 - quick bar clamp and spreader, 100 mm span length, 30 mm depth. Nylon fibre filled jaws. Using for spreading too.

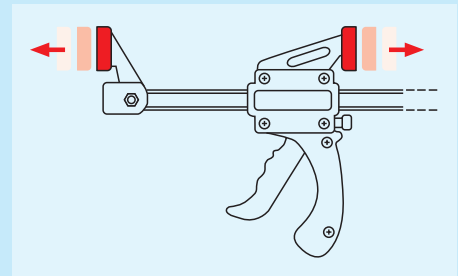
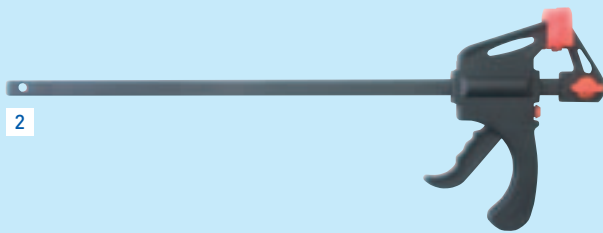

3) Art. 20S-19/300 Schwere Schnellspannzwinde 300 mm Spannlänge, 50 mm Spanntiefe mit Schonbacken. Backen zum Spreizen umsteckbar.

3) Art. 20S-19/300 quick clamp 300 mm span length, 50 mm depth. Nylon fibre filled jaws. Using for spreading too.

4) Art. M5205500 - Bastlerzwinde 100 mm Spannlänge, 50 mm Spanntiefe

4) Art. M5205500 - DIY worker's clamp, 100 mm span length, 50 mm depth

5) Art. M5206500 - Bastlerzwinde 150 mm Spannlänge, 50 mm Spanntiefe

5) Art. M5206500 - DIY worker's clamp 150 mm span length, 50 mm depth

6) Art. M5207500 - Bastlerzwinde 200 mm Spannlänge, 50 mm Spanntiefe,

6) Art. M5207500 - DIY worker's clamp 200 mm span length, 50 mm depth

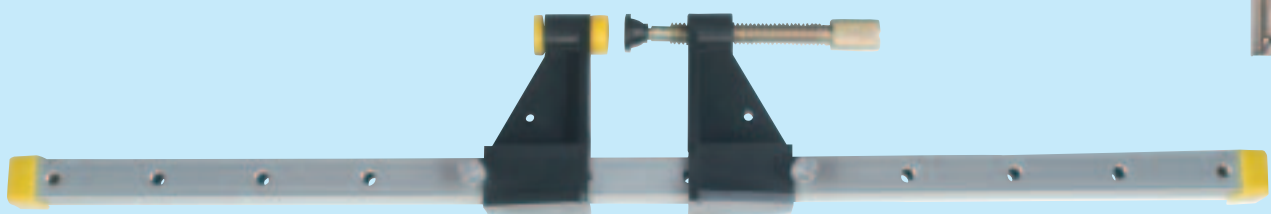
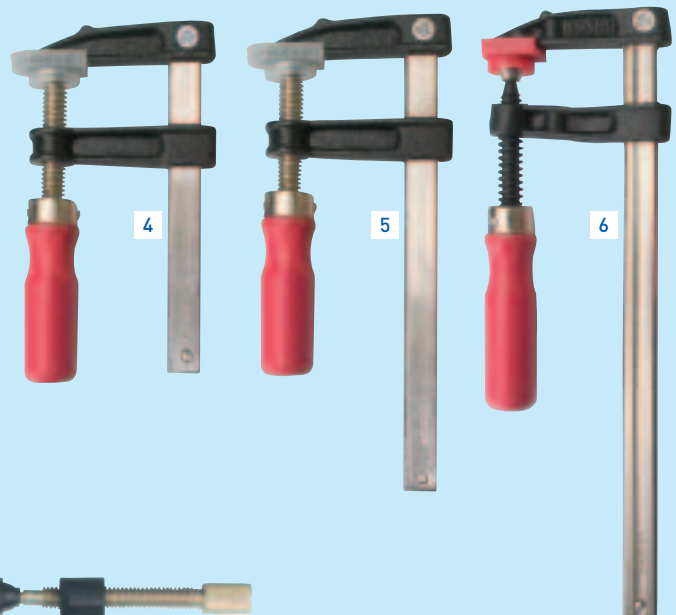

Art. 30S - Mini-Klemmbank, ideal für feine Klemmarbeiten in Modellbau und Feinmechanik. Die beiden Klemmbanken laufen auf einer Aluschiene und sind stufenweise fixierbar. Klemmlänge max. 230 mm

Art. 30S - mini-clamp-bench, for working exactly in model-building and precision engineering. Maximum span length 230 mm

LötKolben und Heißbrenner

torches for electrical and electronic work



1) Art. MT1000K
Heißbrenner-Set in Kassette, Inhalt: Grundgerät, Ablageständer, Flammenfächer, Weichlötaufsatz mit 4 verschiedenen Lötspitzen, Styroporschneidmesser und -schneidenadel, Heißluftdüse mit Umlenklech, Schutzkappe mit Anzünder

1) Art. MT1000K
Gas torch set in cassette, contents: basic tool, heat deflector, holder, solder head with 4 soldering iron bits, polyform cutter as knife and needle, hot air tip with deflector, protective cap with lighter



2) Art. MT100
Heißbrenner Grundgerät, mit Heißbrennerdüse

2) Art. MT100
Gas torch basic tool, with hot blow nozzle



3) Art. MT3020
Profi-Gasbrenner Standgerät (Metallgehäuse). Die 1300 °C heiße Flamme schmilzt Glas und Metall (z.B. Zinn, Alu, Kupfer, Gold, Silber usw.). Das elektronische Zündsystem sorgt für eine schnelle Zündung, der 94 ml Tank erlaubt ein Arbeiten bis zu 2 Std. mit nur einer Füllung Butan Feuerzeuggas. Die große Fußplatte von 70 x 70 mm garantiert sicheren Stand. Maße: Ø 35 mm, 155 x 75 mm

3) Art. MT3020
Butane power system (metal body). For all small works with soldering and welding. The ignition button starts flame immediately. The temperature of 1300 °C (2370 °F) melts glass and metal (tin, aluminium, copper, gold, silver etc.). The volume of 94 ml of the butane gas tank enables you to work up to 2 hours with only one filling. Size: Ø 35 mm, 155 x 75 mm

Kreative Heißbrenner
Heißbrenner mit Aufsätzen zum Hartlöten, Schmelzen, Verbiegen, Erhitzen, Ausglühen, Farbablösen, Weichlöten, Einschrumpfen, Schneiden und Modellieren von Kunststoff, Hartschaum, Moltopren und Styropor. Geeignet für Arbeiten mit Gold, Silber, Kupfer sowie anderen Metallen und Legierungen. Alle Geräte sind mit handelsüblichem Butan Feuerzeuggas füllbar. Die Flamme ist regulierbar und erreicht eine Temperatur von 1300 °C. Die Weichlötspitzen bringen etwa die Leistung eines 60 Watt ElektrolötKolbens.

Butane solder irons
Soldering irons and torches for electrical and electronic work. Melts gold, silver and small copper rods. For hobbyists and professionals – fillable with butane gas lighter fuel. Different slip-on heads possible. The flame is adjustable and can reach temperatures of 1300 °C (2370 °F).

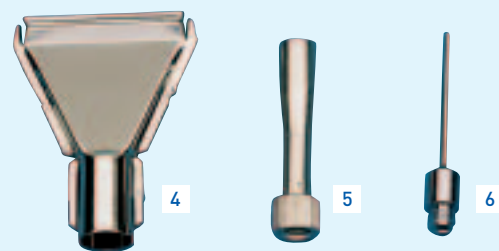

- 4) Art. MT100/4 - Flammenfächer
- 4) Art. MT100/4 - heat deflector
- 5) Art. MT100/2 - Heißluftdüse
- 5) Art. MT100/2 - hot air tip
- 6) Art. MT100/5 - Styroporschneidenadel
- 6) Art. MT100/5 - polyform cutter as needle

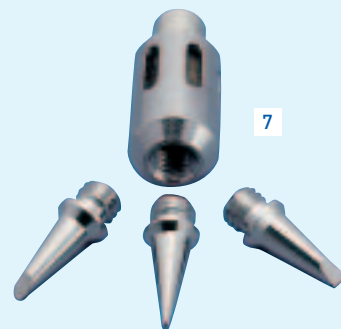

- 7) Art. MT100/1 - Weichlöt-Aufsatz für MT100 mit 3 Lötspitzen
- 7) Art. MT100/1 - soldering head for MT100 with 3 soldering tips

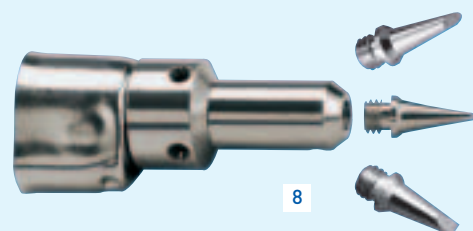

- 8) Art. MT3020/1 - Weichlöt- und Heißluft-Aufsatz für MT3020 mit 3 Lötspitzen
- 8) Art. MT3020/1 - soldering and hot air head for MT3020 with 3 soldering tips

Bastlerzubehör

DIY accessories

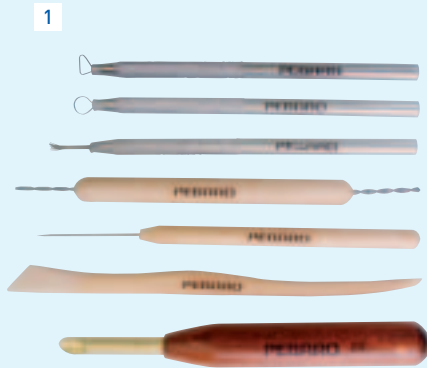

- 1) Art. TOE200 – 7-teiliges Töpfer-set zum Modellieren
- 1) Art. TOE200 – pottery set, 7 pcs.
- 2) Art. TOE300 – 8-teiliges Töpfer-set zum Modellieren
- 2) Art. TOE300 – pottery set, 8 pcs.

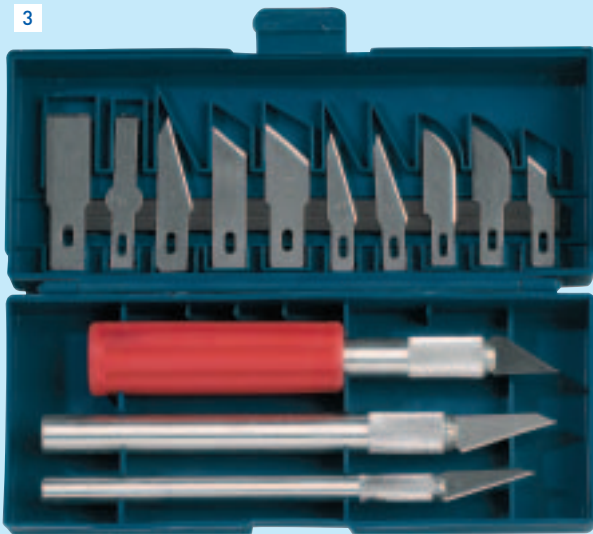

- 3) Art. 17-1S - Designer-Messer-Set
Qualitätsmesser und Klingen für Hobby, Handwerk, Modellbau, Kunst und Schnitzerei mit 3 Griffen und 13 verschiedenen wechselbaren Klingen. Klingenhalterung aus Aluminium - kein Kunststoff!
- 3) Art. 17-1S - precision knife set
3 holders and 13 different blades for hobby, trade, craft, model, carving. Aluminium holder for blades - no plastic parts!



- Art. PZ-54 - Pinzettenset
4 verschiedene rostfreie Pinzetten, 105-120 mm in Kunststofftasche: Spitzpinzette gerade, Spitzpinzette gebogen, Flachpinzette leicht gebogen und Kreuzpinzette
- Art. PZ-54 - set of tweezers
4 different stainless tweezers, 105-120 mm in bag: straight point, angled point, offset flat, reverse action point



- 4) Art. 17M - Präzisionsmesser mit handlichem Aluminiumgriff, Ø 8 mm, 140 mm, ideal für sauberes und präzises Arbeiten, 6 Klingen. Klingenhalterung aus Aluminium - kein Kunststoff!
- 4) Art. 17M - precision knife with aluminium handle dia. 8 mm, 140 mm, 6 blades. Aluminium holder for blades - no plastic parts!

- Art. 17-10KL (o. Abb.) - Ersatzklingen für Präzisionsmesser 17M, 10 Stück.
- Art. 17-10KL (not pictured) - blades for precision knife, 10 pcs.

Bastlerzubehör DIY accessories



Art. LB820 - Lupenbrille mit LED Licht
inkl. 3 Linsen für die wechselbare vielfache
Vergrößerung (1,5-fach, 2,5-fach, 3,5-fach)
Art. LB820 - supporting glasses magnifier
with LED lamp, incl. 3 lenses with changeable
magnifying multiple (1.5x, 2.5x, 3.5x)



Art. LL810 - Leuchtlupe mit 4 LEDs
Lupengröße 80 x 80 mm, 3-fache Vergrößerung.
Winkel justierbar zwischen 120 und 180 Grad.
2 Mignon Batterien (AA) - nicht enthalten.
Art. LL810 - magnifying glass with 4 lights
lens size 3"x 3", lens magnifying multiple 3x,
angle adjustable between 120 and 180 degrees.
2 x AA batteries not included.



Art. LF800 - Flexoleuchte mit
Saugnapf und 3 Batterien
Art. LF800 - flexible lamp with
suction pad, 3 batteries
included

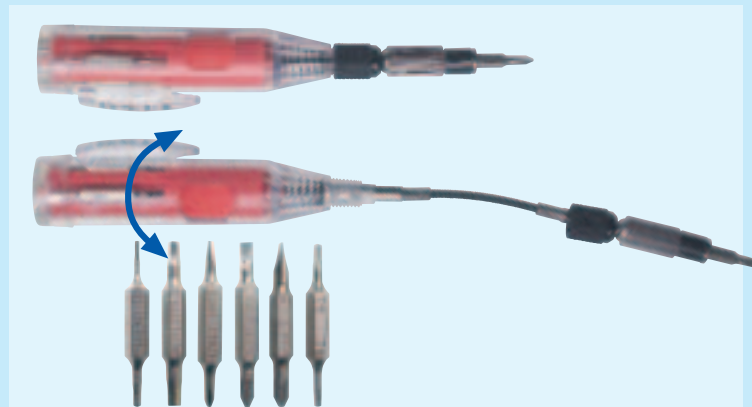

Art. MBS12 - Mini-Bit-Flexi-Dreher
Schraubendreher mit flexiblem und festem Schaft und 6 doppelseitigen
Mini-Bits, besonders für Arbeiten an unzugänglichen Stellen. Alle Bits im
Schaft verstaut: 3 Schlitz 2,0 / 2,5 / 3,0 mm, 3 Kreuzschlitz Typ PH00 / PH0 /
PH1, 4 Sechskant 0,9 / 1,5 / 2,0 / 2,5 mm, 2 Torx T5 / T6
Art. MBS12 - mini-bit screwdriver
With flexible and fixed shaft to work in narrow areas. With 6 double side
bits stored in the shaft. 3 slotted 2.0 / 2.5 / 3.0 mm, 3 cross point type
PH00 / PH0 / PH1, 4 hexagon 0.9 / 1.5 / 2.0 / 2.5 mm and 2 Torx T5 / T6



Art. MBS18 - Flexo-Schraubendreher mit
flexiblem Schaft und starrem Teleskop-
schaft, 18 Mini-Bits: 5 Schlitz 1,0 / 1,5 / 2,0 /
2,5 / 3,0 mm, 4 Kreuzschlitz Typ PH000 /
PH00 / PH0 / PH1, 3 Sechskant 1,5 / 2,0 /
2,5 mm, 6 Torx T5 / T6 / T7 / T8 / T9 / T10,
in Kassette
Art. MBS18 - mini-bits and screwdriver with
flexible shaft and extendible fixed shaft,
18 precision bits: 5 slotted 1.0 / 1.5 / 2.0 / 2.5 /
3.0 mm, 4 cross point type PH000 / PH00 /
PH0 / PH1, 3 hexagon 1.5 / 2.0 / 2.5 mm,
6 torx T5 / T6 / T7 / T8 / T9 / T10, in plastic
case



Art. MBS10 - Mini Ratsche
auf Karte mit Rechts-/Linkslauf,
10 verschiedene Mini-Bits in Steck-
leiste: 3 Schlitz 1,0 / 2,0 / 3,0 mm,
3 Kreuzschlitz Typ PH00 / PH0 / PH1,
4 Sechskant 1,3 / 1,5 / 2,0 / 2,5 mm.
Ratsche passend für alle 4 mm Mini-Bits.
Art. MBS10 - mini ratcheted with right/left motion
and 10 bits in holder: 3 slotted 1.0 / 2.0 / 3.0 mm,
3 cross point type PH00 / PH0 / PH1, 4 hexagon 1.3 /
1.5 / 2.0 / 2.5 mm. Expandable with all 4 mm mini-bits.



Elektronik-Schraubendreher Sets

electronic screwdriver sets

Elektronik-Schraubendreher Sets in verschiedenen Ausführungen: Schlitz, Kreuz, Sechskant, Steckschlüssel. Hochwertige Präzisions-Schraubendreher mit gehärteten Spitzen aus Nickel-Chrom-Molybdän-Stahl mit schwarzen Spitzen (reduziert die Lichtreflektion) und farbig drehbarer Kuppe für schnelles und leichtes Drehen/Zwirbeln. Griffe aus Polyamid (PA6).

Electronic screwdriver sets in different models: slotted point, cross point, hexagon, metric nut spinner. Made of hardened and tempered alloy steel. Points nickel-chrome-molybdenum steel. Black points reducing light reflection, swivel top for miniature work. Handle polyamide (PA6).

Art. 280-60 - Schlitz Schraubendreher
0,8 / 1,0 / 1,2 / 1,5 / 1,8 / 2,0 mm, 40 mm
Art. 280-60 - slotted screwdrivers
0.8 / 1.0 / 1.2 / 1.5 / 1.8 / 2.0 mm, 40 mm

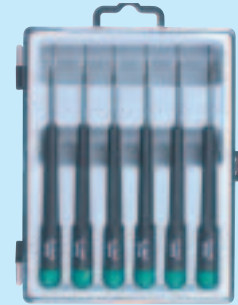

Art. 280-61 - Kreuzschlitz Schraubendreher
PH0-3 / PH0-2 / PH0 / PH1-2 /
Pozidrive 0 + 1, 40 mm
Art. 280-61 - cross point
PH0-3 / PH0-2 / PH0 / PH1-2 /
Pozidrive 0 + 1, 40 mm



Art. 280-63 - Sechskant Schraubendreher
0,7 / 0,9 / 1,3 / 1,5 / 2,0 / 2,5 mm, 40 mm
Art. 280-63 - hexagon metric
0.7 / 0.9 / 1.3 / 1.5 / 2.0 / 2.5 mm, 40 mm



Art. 280-65 Innensechskant-Steckschlüssel
für Muttern M2 / M2,5 / M3 / M3,5 /
M4 / M5, SW 4 / 5 / 5,5 / 6 / 7 / 8, 50 mm
Art. 280-65 - metric nut spinners
for nuts M2 / M2.5 / M3 / M3.5 / M4 / M5
SW 4 / 5 / 5.5 / 6 / 7 / 8, 50 mm



Art. 280-66 Innensechskant-Steckschlüssel
für Muttern M1 / M1,2 / M1,4 / M1,6 /
M1,8 / M2, SW 2,5 / 3 / 3 / 3,2 / 3,5 / 4, 40 mm
Art. 280-66 metric nut spinners
for nuts M1 / M1.2 / M1.4 / M1.6 /
M1.8 / M2, SW 2.5 / 3 / 3 / 3.2 / 3.5 / 4, 40 mm

