

Aufbauanleitung für Cross Motorrad 850-6

Serie „schwierig“

1

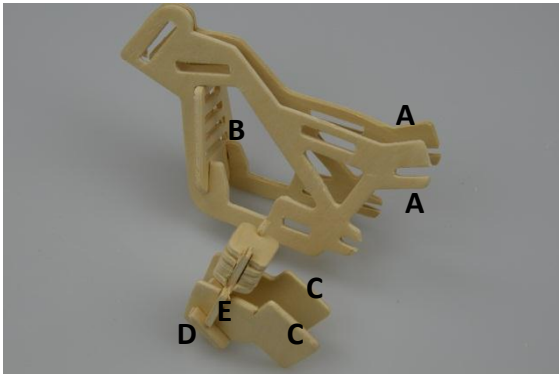

2

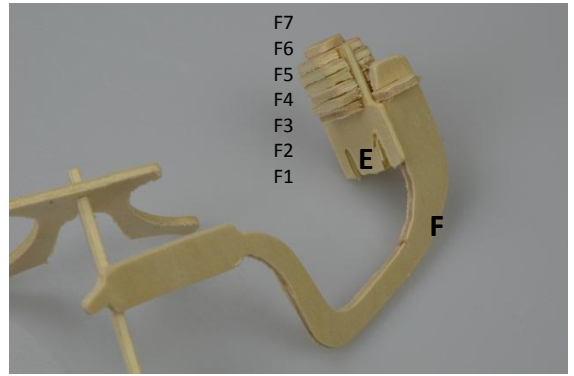

3

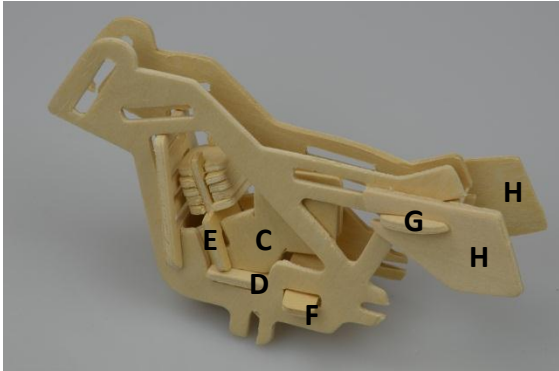

4

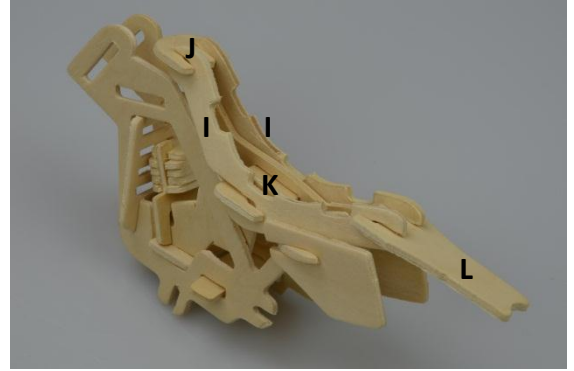

5

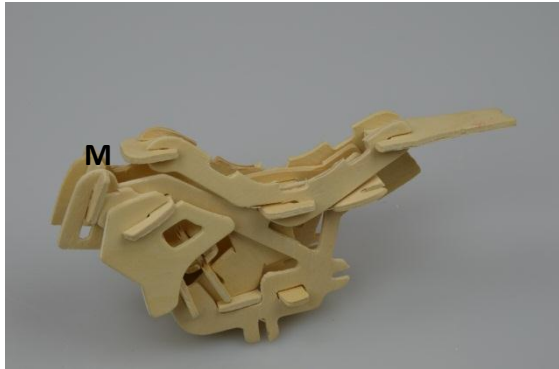

6

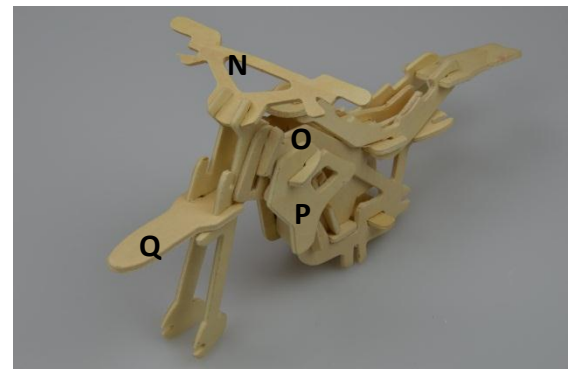

7



8

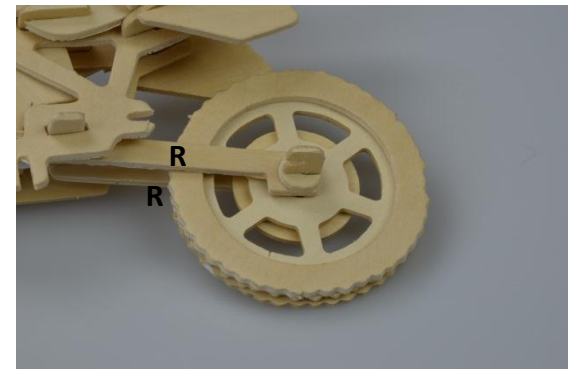

9

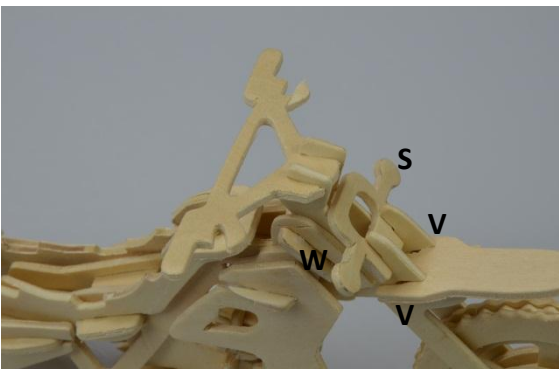

10



11



12



ACHTUNG ! Die Aufbauanleitung ist spiegelbildlich zum Deckblatt

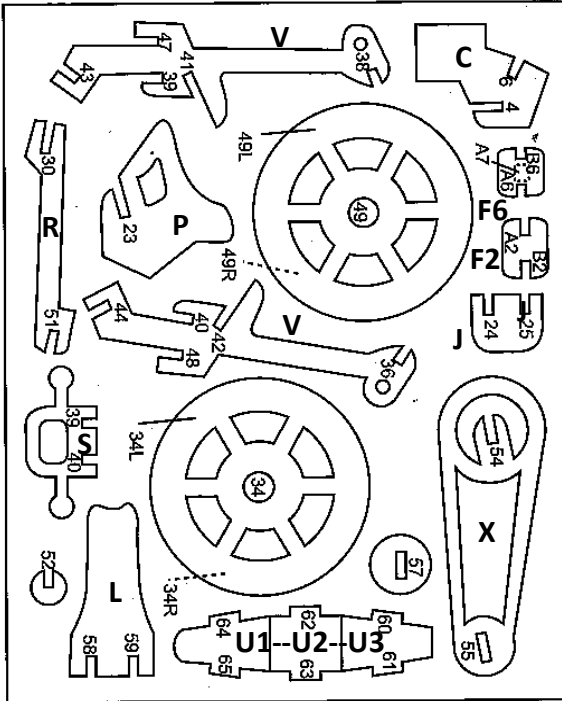

Achtung: U1 – U3 müssen angepasst werden. Mit scharfem Messer trennen und Größe passend schneiden !

CROSS-MOTORRAD

(850/6)

